

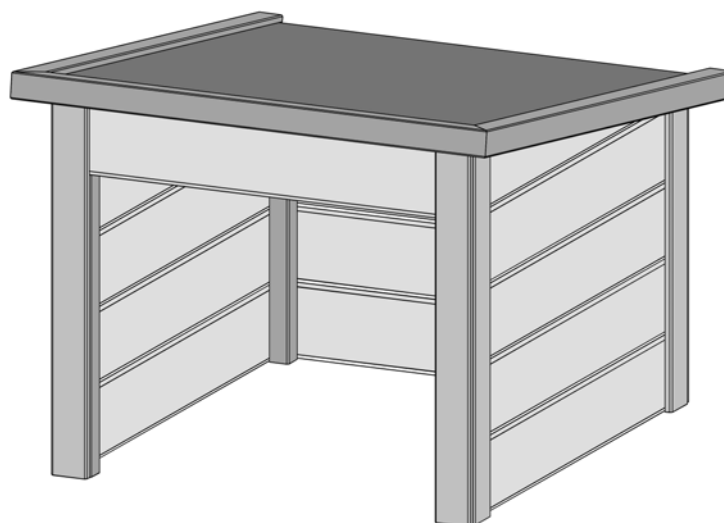

Montage-, Bedienungs- und Wartungsanleitung

en	ASSEMBLY, USER AND MAINTENANCE INSTRUCTIONS
fr	NOTICE DE MONTAGE, D'UTILISATION ET D'ENTRETIEN
it	ISTRUZIONI DI MONTAGGIO, USO E MANUTENZIONE



Rasenmähergarage

**Art.-Nr.: 367.1000.16400
367.1000.20400**

Stand: 1406

- de -

**Sehr geehrte Kundin, sehr geehrter Kunde,
danke, daß Sie sich für ein weka – Produkt entschieden haben.**

- Lesen Sie diese Anleitung vor dem Aufbau bitte vollständig durch, um Montagefehler oder Beschädigungen zu vermeiden.
- **WICHTIG !**
Prüfen Sie bitte sofort anhand der Packliste, ob das weka-Produkt vollständig und unbeschädigt bei Ihnen angekommen ist.
- Bitte vernichten Sie die Packliste erst nach Ablauf der Garantiezeit. Diese Liste dient Ihnen zur Kontrolle auf Vollständigkeit der Einzelteile und ist mit dem Kaufbeleg aufzubewahren. Eventuelle Beanstandungen können mit Hilfe dieser Liste problemlos behoben werden. Die Pos.-Nummern der Packliste stimmen nicht mit den Pos.-Nummern folgender Montageanleitung überein.
- Wir empfehlen Ihnen die Montage mit 2 Personen durchzuführen.
- Zur Verhütung von Unfällen ist zu vermeiden, daß sich Kinder während der Montage in unmittelbarer Nähe befinden.
- Weiterentwicklungen im Sinne des technischen Fortschritts behalten wir uns vor. So können geringfügige Abweichungen in den Darstellungen entstehen.
- Verpackungsmaterial nicht einfach wegwerfen! Papier-, Pappe- und Wellpappeverpackungen, sowie Kunststoffverpackungsteile sollten in die entsprechenden Sammelbehälter gegeben werden.

EMPFEHLUNGEN / HOLZSCHUTZ

- Bitte bohren Sie alle Schraubverbindungen vor, um Beschädigungen an den Holzteilen zu vermeiden!
- Schützen Sie das Holz vor stundenlanger, direkter Sonneneinwirkung oder Feuchtigkeit.
- Um aufsteigende Feuchtigkeit zu verhindern, empfehlen wir, zwischen dem Fundament und den Bodenbalken eine Sperrschicht aus der Verpackungsfolie, Dachpappe o.ä. zu verlegen. Die Sperrschicht aus Dachpappe ist nicht im Lieferumfang enthalten.
- Grundsätzlich sollten Sie einen Fachmann für Holzanstrichmittel konsultieren!
- **Nach Fertigstellung des Hauses geben Sie dem gesamten Haus von außen einen mehrfachen Schutzanstrich (mindestens zwei Anstriche) einer offenporigen Holzschutzlasur.**
- Ein regelmäßiger Anstrich gemäß der Herstellerangaben der Holzschutzlasur ist zum Schutz des Holzes notwendig.

WERKZEUG

Folgendes Werkzeug sollten Sie vor Beginn der Montage zurecht gelegt haben.

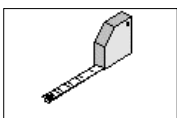

Bandmaß

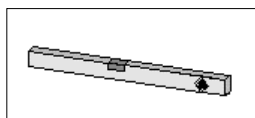

Wasserwaage

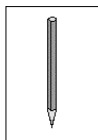

Bleistift

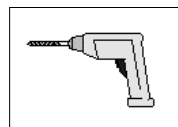

Bohrmaschine

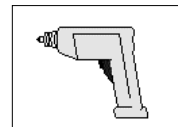

Elektroschrauber

- en -

Dear customer

Thank you very much for choosing a weka product.

- Read these instructions through completely before assembling your product in order to avoid errors in assembly or damage.
- **IMPORTANT**
Please use the enclosed packing list to check immediately that your weka product has been delivered complete and intact.
- Please do not dispose of the packing list before the guarantee period has expired. This list enables you to check that all the individual parts are present. It should be retained along with the proof of purchase. Any complaints which may arise can probably be easily rectified with this list. The item numbers on the packing list do not correspond to the item numbers in the following assembly instructions.
- We recommend that 2 people carry out the assembly.
- In order to prevent accidents, we recommend that children are kept out of the direct vicinity during assembly.
- We reserve the right to make further technological developments. This means that there may be minor deviations in the illustrations.
- Please do not simply throw away the packaging material. Paper, card and corrugated board as well as plastic packaging materials should be placed in the correct collection containers.

RECOMMENDATIONS / WOOD PROTECTION

- Please drill pilot holes for all screw connections to avoid damaging the wood.
- In order to avoid rising damp, we recommend that a barrier layer using the packaging film, roofing paper or similar be laid between the foundation and the floor beams.
Roofing paper for a barrier layer is not included in the scope of this delivery.
- Before and during assembly, protect untreated wood from direct sunlight or moisture.
- We recommend that you consult an expert in wood treatment agents.
- **Once the structure has been assembled, give the exterior of the entire construction at least two coats of an open-pore wood protection agent.**
- **A regular coating in accordance with the manufacturer's instructions of the wood protection agent is necessary to protect the wood.**

TOOL

You should have the following tools to hand before beginning assembly. (Not supplied.)

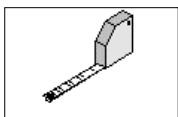

Spring tape measure

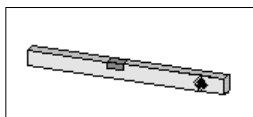

Spirit level

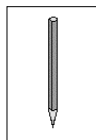

Pencil

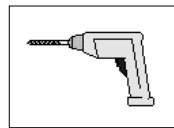

Drill

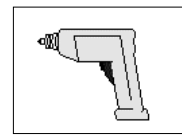

Electric screwdriver

- fr -

Chère Cliente, cher Client

Nous vous remercions d'avoir choisi un produit weka.

- Lisez entièrement la présente notice avant de procéder à l'assemblage afin d'éviter les erreurs et les dommages.
- **IMPORTANT !**
Veillez vérifier immédiatement, à l'aide de la liste des pièces, si le produit weka est arrivé complet et en bon état.
- Ne détruisez la liste des pièces qu'une fois la garantie écoulee. Cette liste vous permet de vérifier si les pièces détachées sont complètes et doit être conservée avec le justificatif d'achat. Elle vous permettra de faire valoir aisément d'éventuelles réclamations. Les numéros de pos. de la liste des pièces ne sont pas identiques aux numéros de pos. de la présente notice de montage.
- Nous vous recommandons d'effectuer le montage à 2 personnes.
- Afin de prévenir tout accident, éviter la présence d'enfants à proximité durant le montage.
- Nous nous réservons le droit d'apporter aux produits des modifications dans le cadre de l'évolution technique. De légères différences sont par conséquent possibles par rapport aux illustrations.
- Ne pas jeter simplement le matériel d'emballage! Les emballages en papier, carton et carton ondulé doivent être déposés dans le container de tri correspondant.

RECOMMANDATIONS / PROTECTION DU BOIS

- Pré-percez tous les assemblages vissés afin d'éviter d'endommager les éléments en bois!
- Protégez le bois non traité du soleil et de l'humidité avant et durant le montage!
- Demandez toujours conseil à un spécialiste du traitement du bois!
- **Lorsque l'assemblage est terminé, traitez entièrement l'extérieur de l'abri en appliquant plusieurs couches (au moins deux) de lasure protectrice à pores ouverts.**
- La lasure protectrice doit être appliquée de manière régulière conformément aux instructions du fabricant pour assurer la protection du bois.

OUTIL

Pour le montage, nous vous recommandons de préparer les outils suivants.
(N'est pas compris dans la fourniture!)

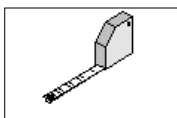

Décamètre à ruban

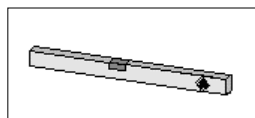

Niveau à bulle

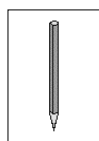

Crayon

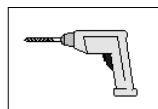

Perceuse



visseuse électrique

- it -

**Egredi clienti,
ci congratuliamo con voi per avere scelto un prodotto weka.**

- Prima del montaggio leggete con cura le presenti istruzioni al fine di evitare errori di montaggio o danni.
- **IMPORTANTE !**
Controllate subito con l'ausilio della lista di imballaggio che il prodotto weka sia stato fornito completo e senza danni.
- Vi preghiamo di conservare la lista di imballaggio solo alla scadenza del periodo di garanzia. Questa lista serve per controllare la completezza della fornitura e deve essere conservata insieme allo scontrino. Con l'ausilio della lista è possibile risolvere eventuali reclami. I numeri di posizione della lista di imballaggio non corrispondono con i numeri di posizione delle seguenti istruzioni di montaggio.
- Raccomandiamo di eseguire il montaggio in 2 persone.
- Per scongiurare eventuali incidenti tenere lontano i bambini dal luogo di montaggio
- Ci riserviamo di apportare modifiche ai fini del progresso tecnologico. Per tale motivo è possibile che nelle rappresentazioni vengano a crearsi lievi differenze.
- Non gettare via il materiale di imballaggio! La carta, il cartone normale e ondulato cosiccome gli imballaggi in plastica devono essere smaltiti negli appositi contenitori di raccolta.

RACCOMANDAZIONI / PROTEZIONE LEGNO

- Per evitare danni agli elementi in legno si raccomanda di preforare tutti i punti di avvitaggio a vite!
- Proteggete il legno non trattato o naturale prima e durante il montaggio dai raggi solari diretti o dall'umidità!
- Si raccomanda di consultare sempre uno specialista per vernici da legno!
- **Dopo aver terminato la costruzione verniciate l'intera casa dall'esterno con più strati di vernice protettiva (almeno due) usando una velatura porosa per legno.**
- Per proteggere il legno è necessario stendere uno strato di velatura ad intervalli regolari come prescritto dal produttore.

UTENSILE

Prima di iniziare con il montaggio tenere a portata di mano i seguenti utensili.
(Non compreso nella fornitura!)

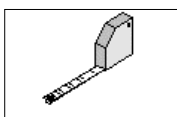

metro a nastro

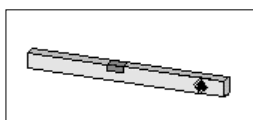

livella ad acqua

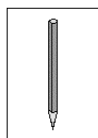

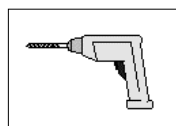

Matita



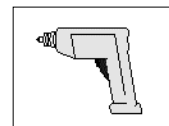

trapano

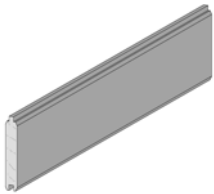
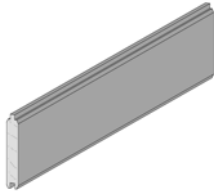
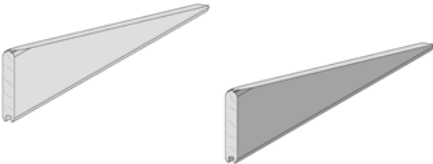
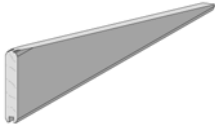
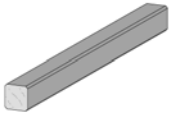
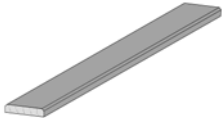

avvitatore elettrico

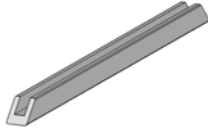
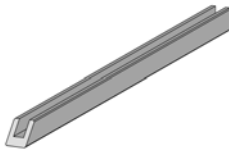
Pos	Bild	Abmessung [mm]	Anzahl [Stück]	
			367.16400	367.20400
①		21 / 121 / 628	5	-
		19 / 121 / 632	-	5
②		21 / 121 / 750	8	-
		19 / 121 / 750	-	8
③		19 / 121 / 750	2	-
④		21 / 121 / 750	-	2
⑤		34 / 34 / 450	4	4
⑥		11 / 58 / 570	8	8
⑦			1	1

Pos	Bild	Abmessung [mm]	Anzahl [Stück]	
			367.16400	367.20400
8		40 / 40 / 778	1	1
9		40 / 40 / 874	2	2
10		4,0 x 50	60	60
11		3,5 x 30	40	40

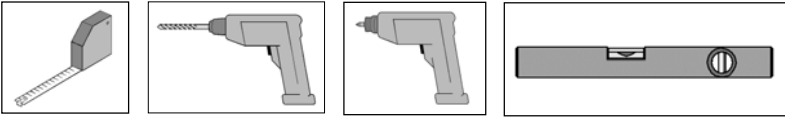

1

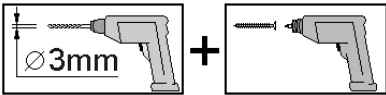
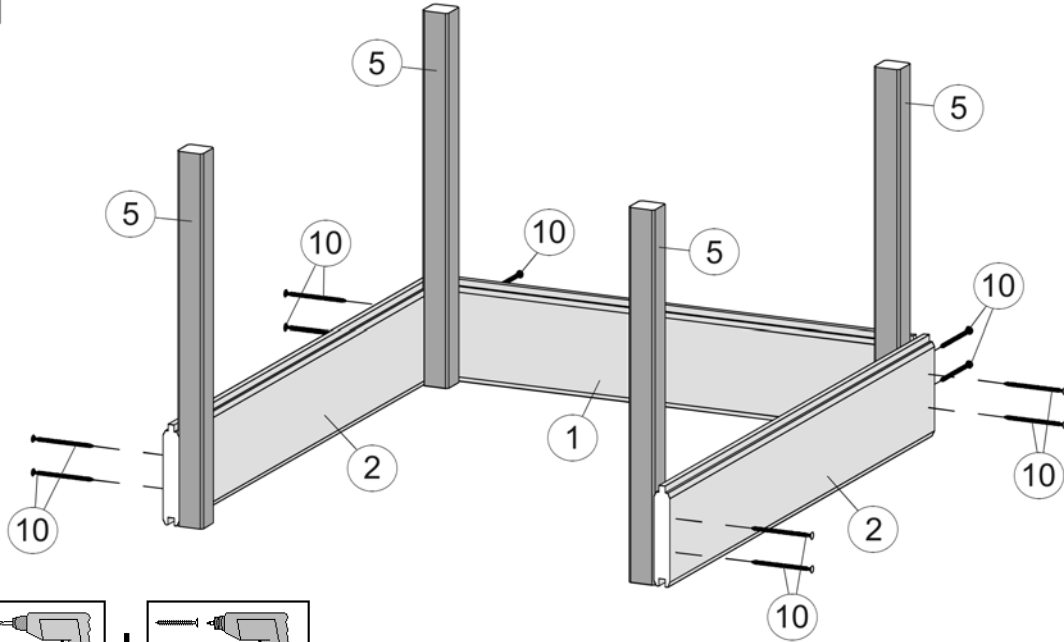

2

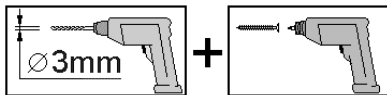
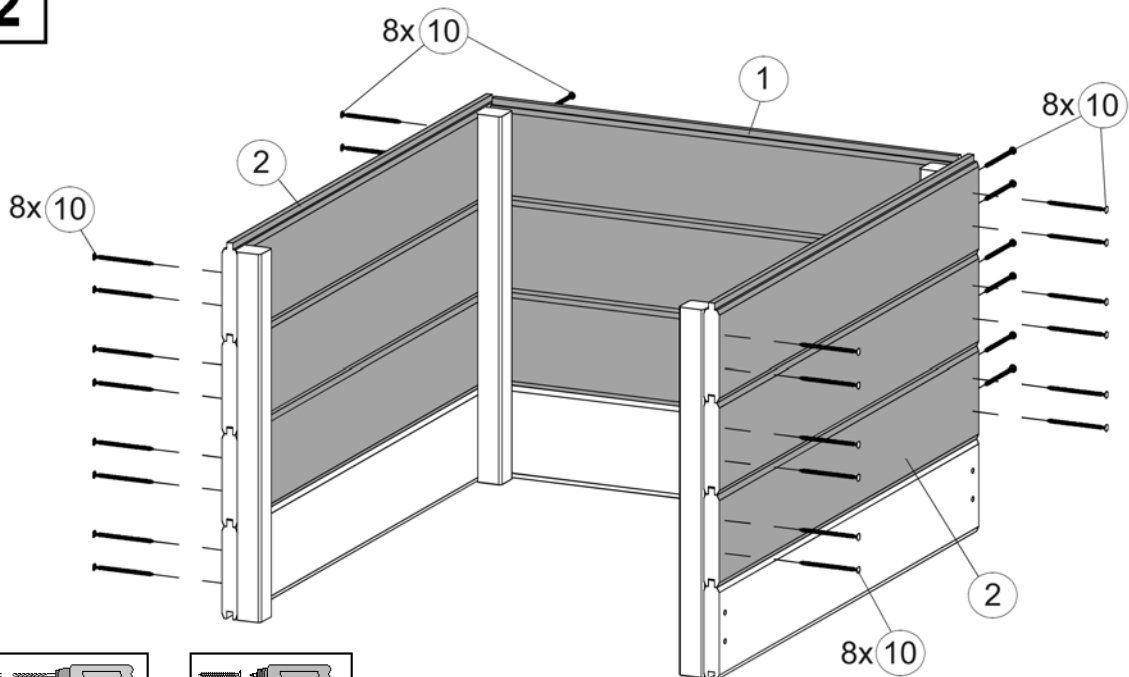

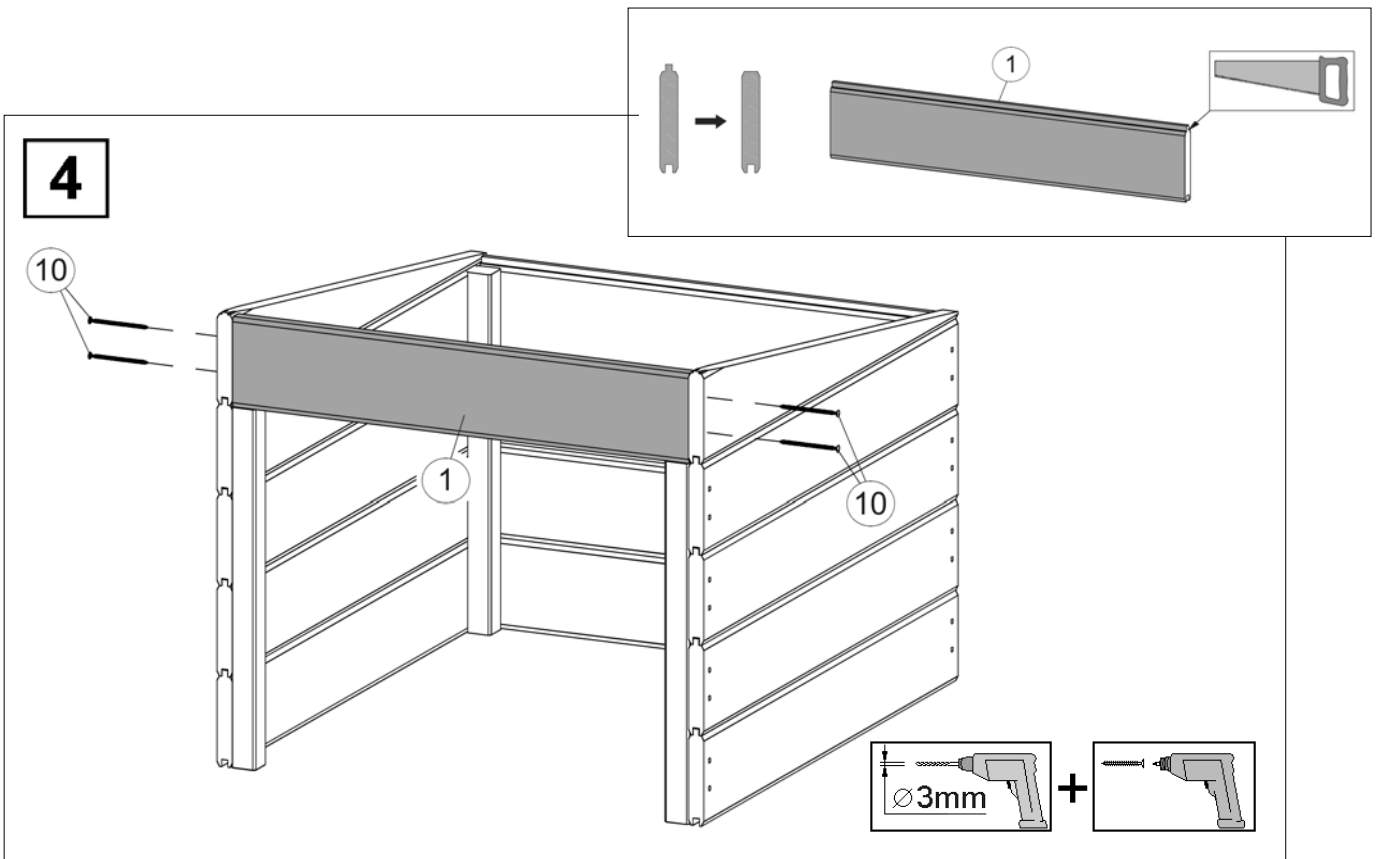
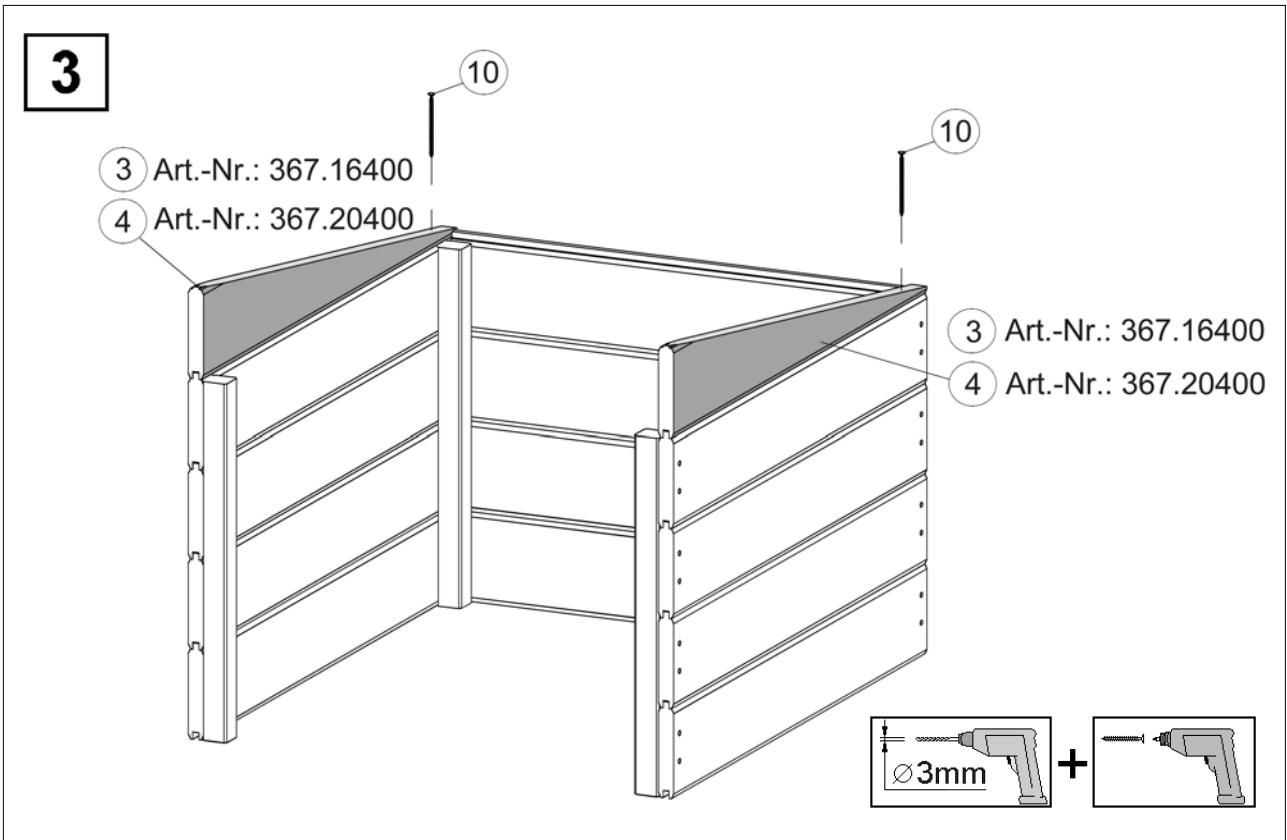
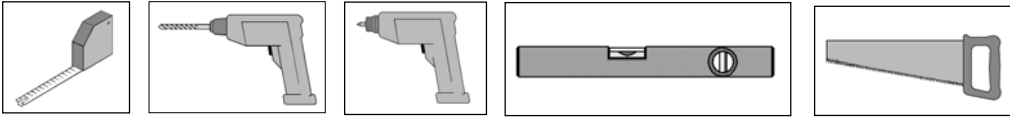

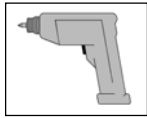
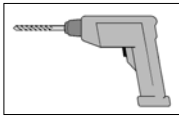
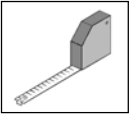

6

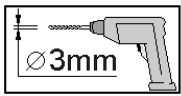
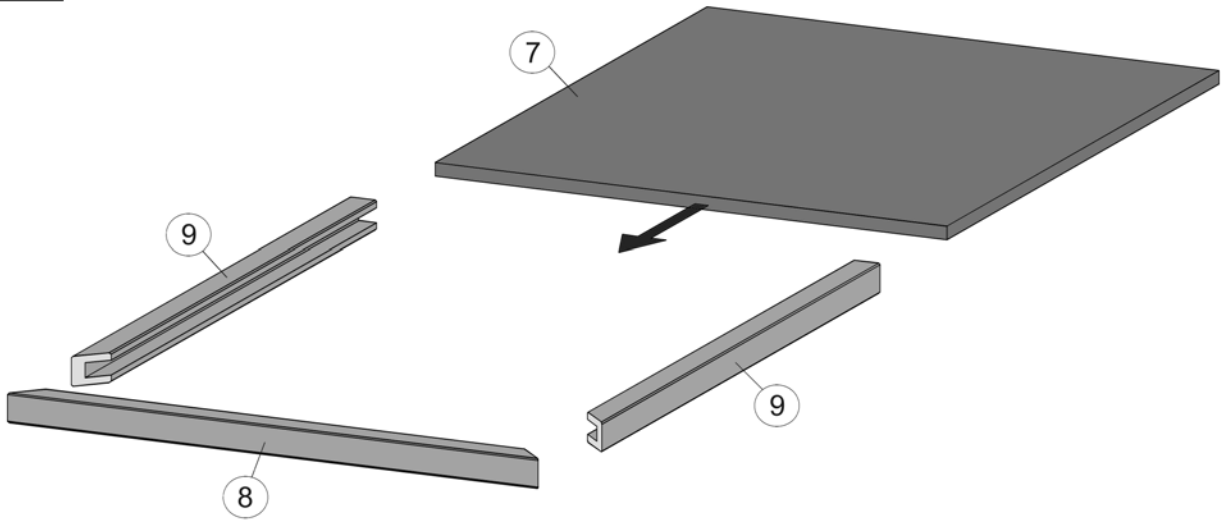

+

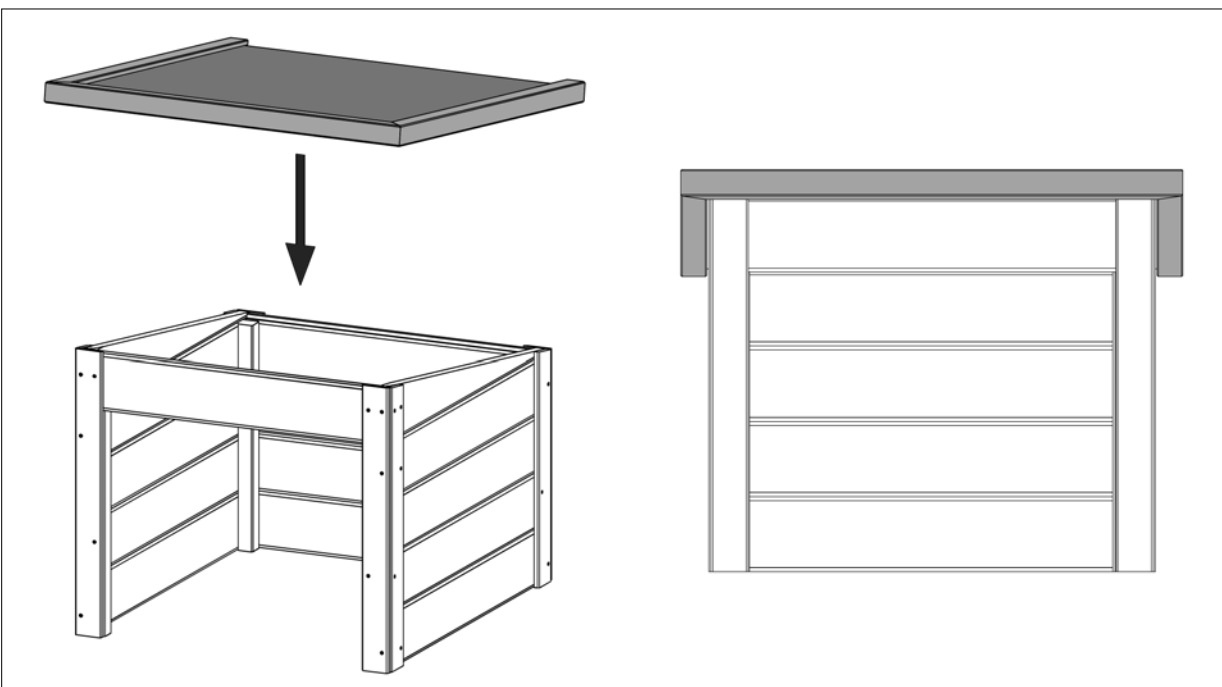
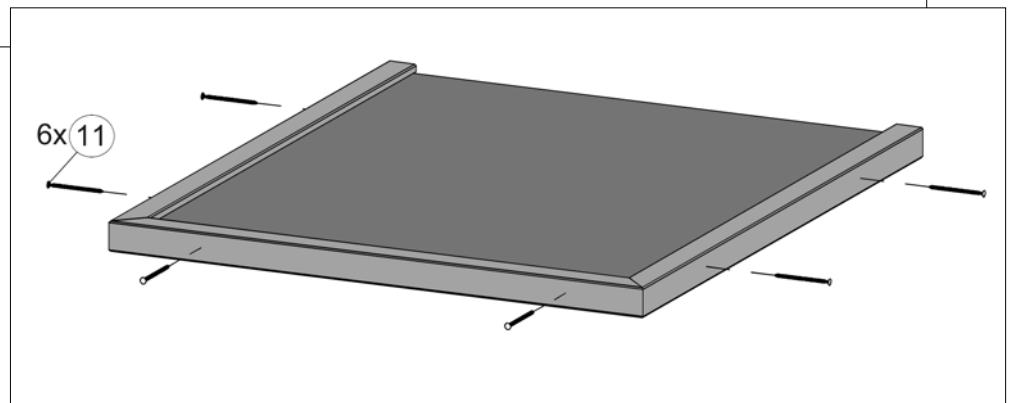
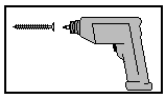



weka Holzbau GmbH,
Johannesstr. 16
D-17034 Neubrandenburg
Tel.: 0395 42908-0
Fax: 0395 42908-83
EMail: Info@weka-Holzbau.com

MA Art.-Nr.: 800.0286.07.40